



Barcode: 5060452080734

transbank™

Product code: TRB4

- » Fully welded unit, for storing and transporting fuels and chemicals.
- » Suitable for vehicle mounting in line with regulations.
- » Designed for storing 4 x 20 litre cans.



Watch the TransBank in action

Product features



Padlock secured



COSHH compliant



Sump capacity



Fire resistant



No detachable parts



Safety signage



Suitable for vehicles

Product specifications

Weight	28kg
Colour	Traffic red: RAL 3020
Suitable for	Transporting flammables & chemicals - 4 x 20L cans
Finished coating	Powder coated
Material & thickness	1.2mm steel
Quantity of keys	No
How are castors fitted?	Not applicable
Other sizes available	4 other sizes
Ventilation	Yes
Qty of shelves as standard	Not applicable

Dimensions

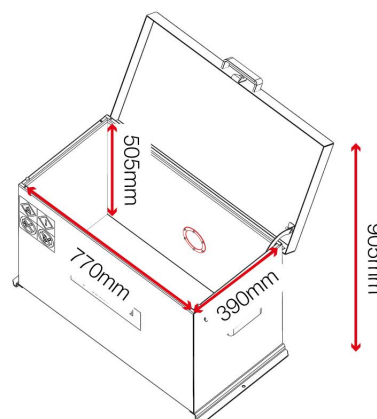
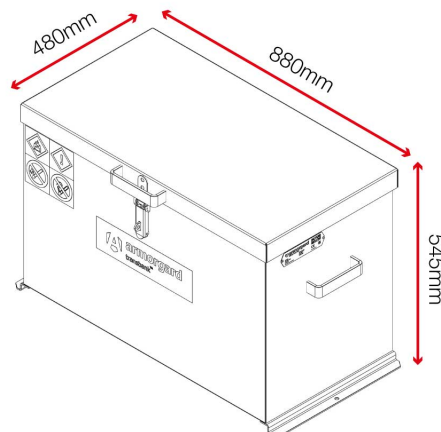

Optional extras - Contact Armorgard to find out more



Padlock LOCK-P50